

 Made in Germany

Pave smart.
Not hard.

Stone-Clamp Multiflex

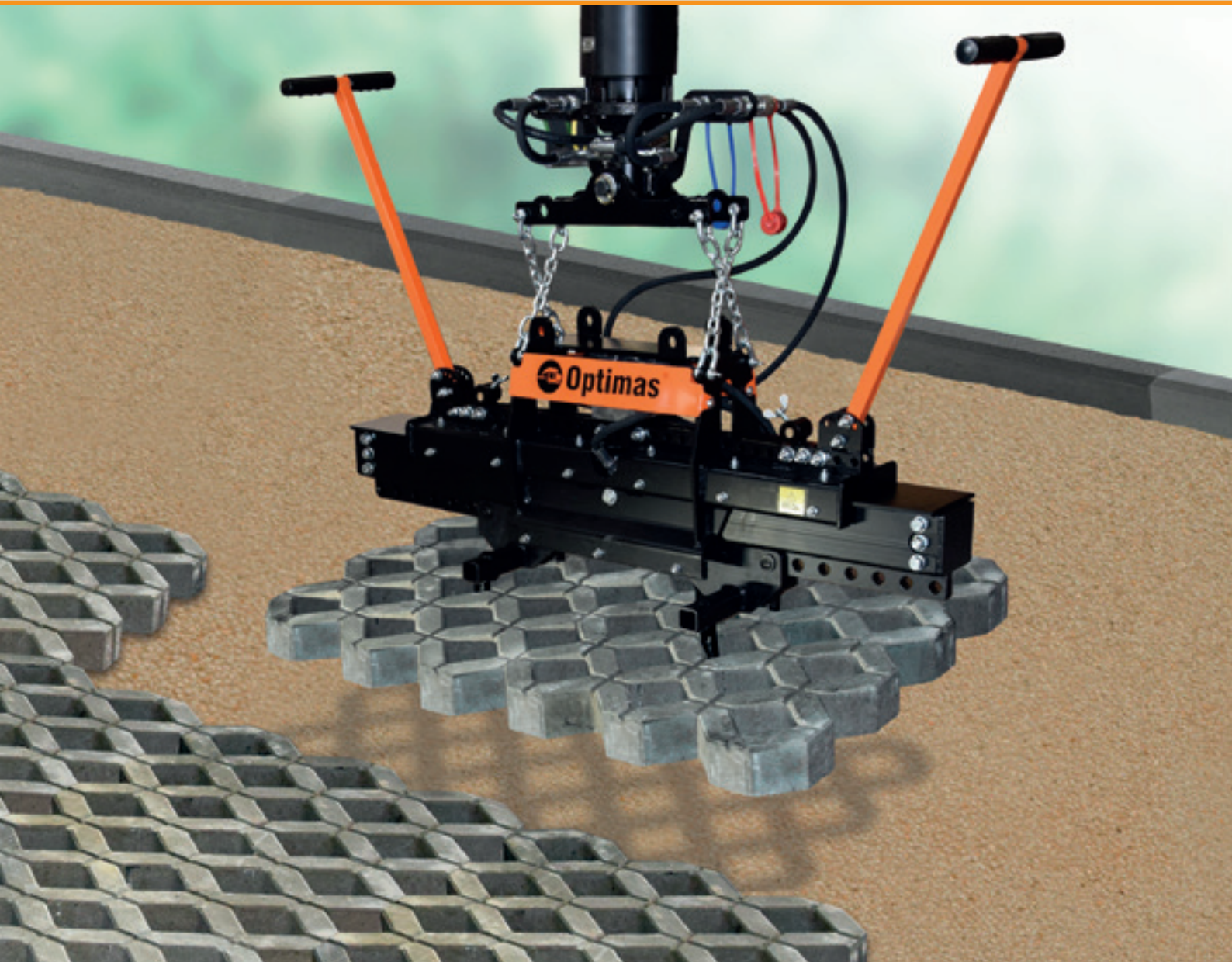

www.optimas.de



Optimas[®]

Versatile in use ...

The Stone-Clamp Multiflex is very quickly and easily mounted on the Optimas Paver Laying machine, or with the appropriate quick-change device, on a carrier device (e.g. excavator) and is then ready for use.

The Stone-Clamp Multiflex is standardly equipped for setting concrete and granite kerbs, gutter stones, block steps and various slabs.

By exchanging the grab jaws (optional), there are many other possible applications, such as setting palisades, L-stones, natural stones, grass pavers, boulders and much more.

Please let us know your desired application and we will clarify the technical details and possibilities. The areas of application of the Stone-Clamp Multiflex are „almost“ unlimited.

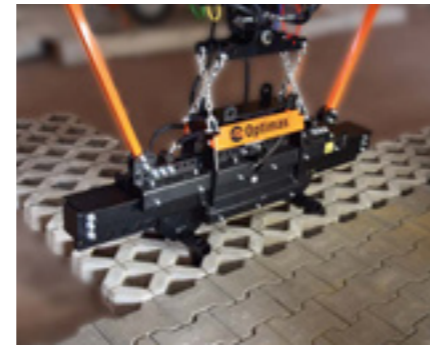

Technical data:

Dead weight:
128 kg (used for Paver Laying machine)
130 kg (used on other carrier)

Load capacity: 400 kg

Adjustment range: 0–140 cm
(optional up to 200 cm)

*Technical changes reserved

Equipment:

Standard equipment Stone-Clamp Multiflex for Optimas Paver Laying machine

- Universal fixture
- 2 stop bracket
- 2 guide handles adjustable
- 2 sets of jaws (e.g. for setting curbs, block steps and various slabs):
 - 2 rubber jaws (75)
 - 2 rubber jaws (135)

Optional:

Various grab jaws available for palisades, L-stones, block steps, natural stones, grass pavers, boulders and much more.



Standard equipment Stone-Clamp Multiflex for any carrier device

- Universal mounting (can be mounted rigidly or loosely suspended on the carrier)
- Hydraulic hoses and couplings to the carrier
- 2 stop handles
- 2 adjustable guide handles
- 2 sets of jaws (e.g. for setting curbs, block steps and various slabs):
 - 2 rubber jaws (75)
 - 2 rubber jaws (135)

Optional:

- Rotary motor 360° (2nd hydraulic circuit required)
- Universal suspension/Quick coupler MS01/MS03/MS08
- Various grab jaws available for palisades, L-stones, block steps, natural stones, grass pavers, boulders, etc.

Your advantages:



- Reduced workload
- Time saving
- Low personnel expenditure
- Simple assembly
- Wide range of applications
- Accurate work result
- Healthy work
- Motivated employees
- Proven Optimas quality

... with a perfect price-performance ratio.

Standard jaws (long)

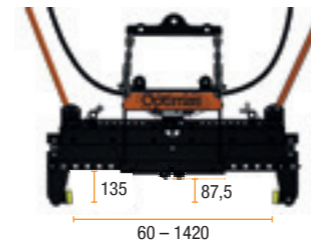

Jaws long (with/without rollers)

Jaws long: For moving high, low and round curbs as well as granite curbs.

Item no. 102244

Standard jaws (short)

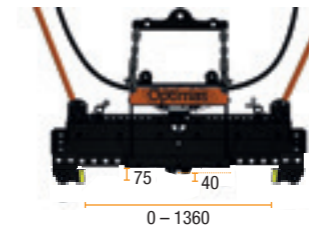

Jaws short (with/without rollers)

Jaws short: For moving high, low and round curbs as well as granite curbs.

Item no. 102081

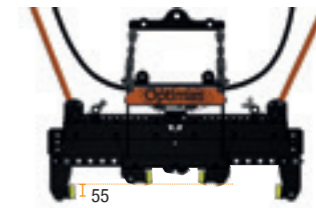

Jaws long + short (with rollers)

Extended jaws

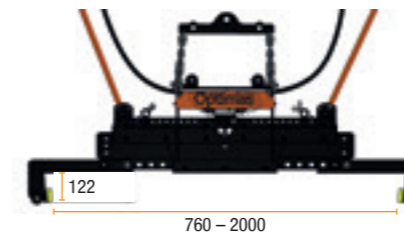

Extended jaws: For moving e.g. block steps

Item no. 103750



Sample display

Depth jaws

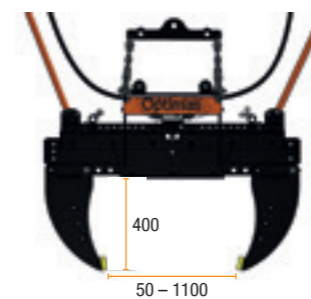

Deep jaws: For setting e.g. rough natural stones, ashlars and L-stones.

Item no. 104840

Boulder jaws (attachment)

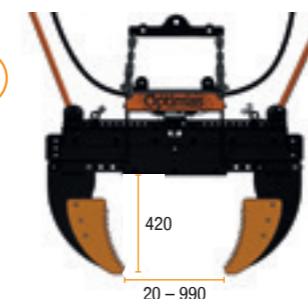

Boulder jaws (as attachment part): For setting e.g. boulders or logs

Item no. 103999

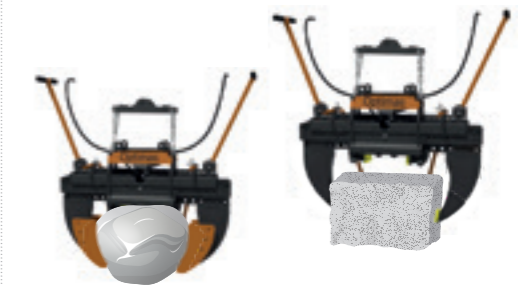

Sample display

Grass pavers jaws (short)

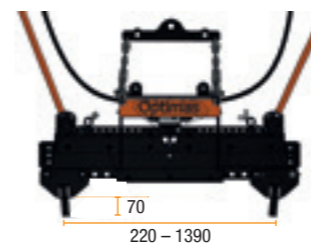

Short grass pavers jaws: For moving 1, 2 and optionally 4 grass pavers

Item no. 104063

Grass pavers jaws (long)

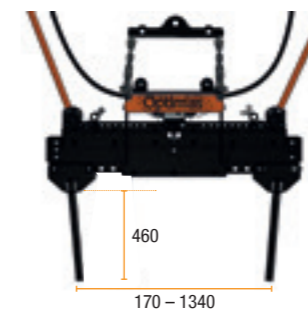

Grass pavers jaws long: For setting 4, 8 and optionally 16 grass pavers (multilayer)

Item no. 104867



Sample display

Stone-Clamp Multiflex (jaws)

Article description

Item	Gripping depth (in mm)	Gripping dimension (in mm)	Weight (in kg)	Intended use	Quantity per device
 Standard jaw (short)	75/40*	0 – 1360	3	For high, low and round curbs and granite curbs	2
 Standard jaw (long)	135**/87,5* /55***	60 – 1420	3,6	For high, low and round curbs and granite curbs	2
 Extended jaw	122	760 – 2000	7,5	For e.g. block steps	2
 Deep jaw	400	50 – 1100	7,5	For e.g. rough natural stones, ashlars and L-stones	2
 Boulder jaw****	420	20 – 990	3,5	For e.g. boulders or logs	4
 Grass pavers jaw (short)	70	220 – 1390	5,2	For 1, 2 and optionally 4 grass pavers	2
 Grass pavers jaw (long)	460	170 – 1340	11,8	For 4, 8 and optionally 16 grass pavers (multilayer)	2

STANDARD

OPTIONAL

*with rollers

**longitudinal gripping

***with jaws short

****as attachment for deep jaw

Contact us!



Optimas[®]
over 40 years of inventiveness!

Optimas Maschinenfabrik · H. Kleinemas GmbH
Industriestraße 12 · D 26683 Saterland-Ramsloh
Germany

Tel.: +49-(0) 4498 / 92 42-0

Fax: +49-(0) 4498 / 92 42-42

e-mail: info@optimas.de · www.optimas.de



Visit us at    